

POWDER PARTS, inc.

EasySelect™ Manual Gun

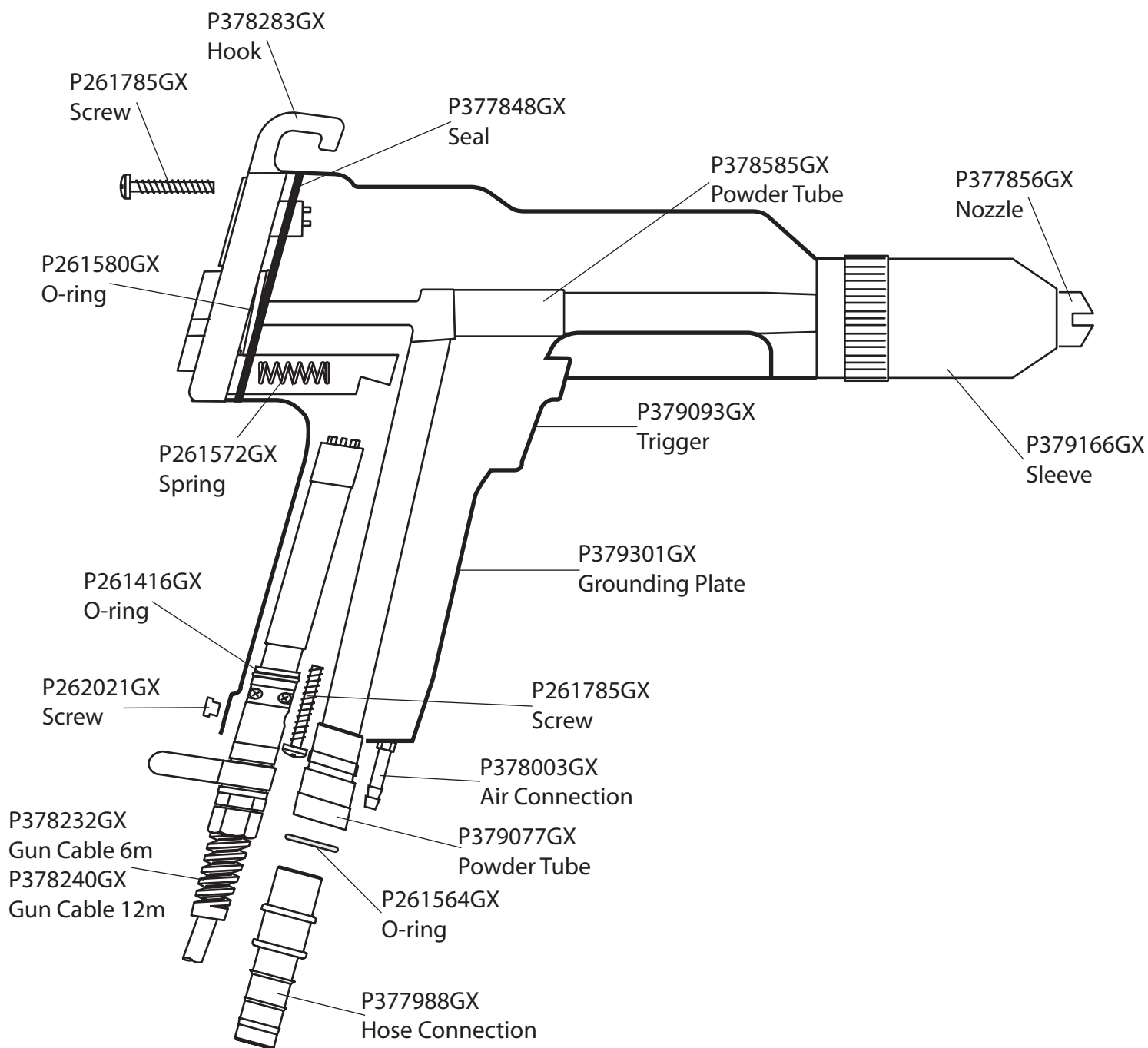

All parts are manufactured by or for Powder Parts, Inc., as "after market" replacement parts for powder coating equipment. The trademark names are owned by their respective companies and are used only for customer convenience.

Nozzle Combination for EasySelect™ Gun

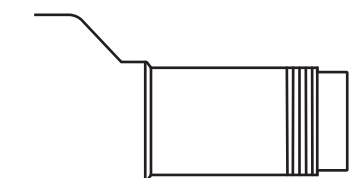

P378852GX
Extension 150mm
P378860GX
Extension 300mm

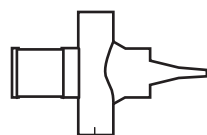
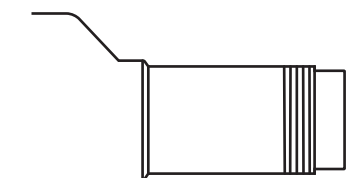

P379140GX
Electrode Holder

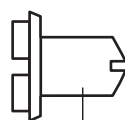

P377856GX
Flat Jet Nozzle

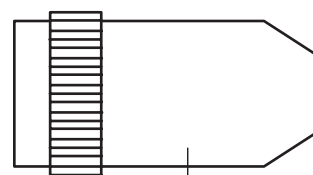

P379166GX
Sleeve

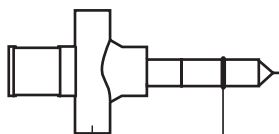
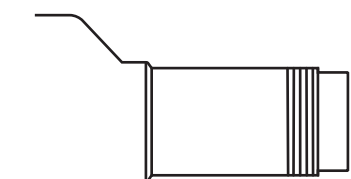

P382914GX
Electrode Holder

P110354GX
O-ring

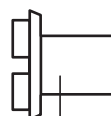

P378518GX
Round Jet Nozzle



P107210GX 16mm Deflector
P107209GX 24mm Deflector
P107208GX 32mm Deflector
P117183GX 50mm Deflector
P117184GX 70mm Deflector

POWDER PARTS, inc.

Easyflow Injector

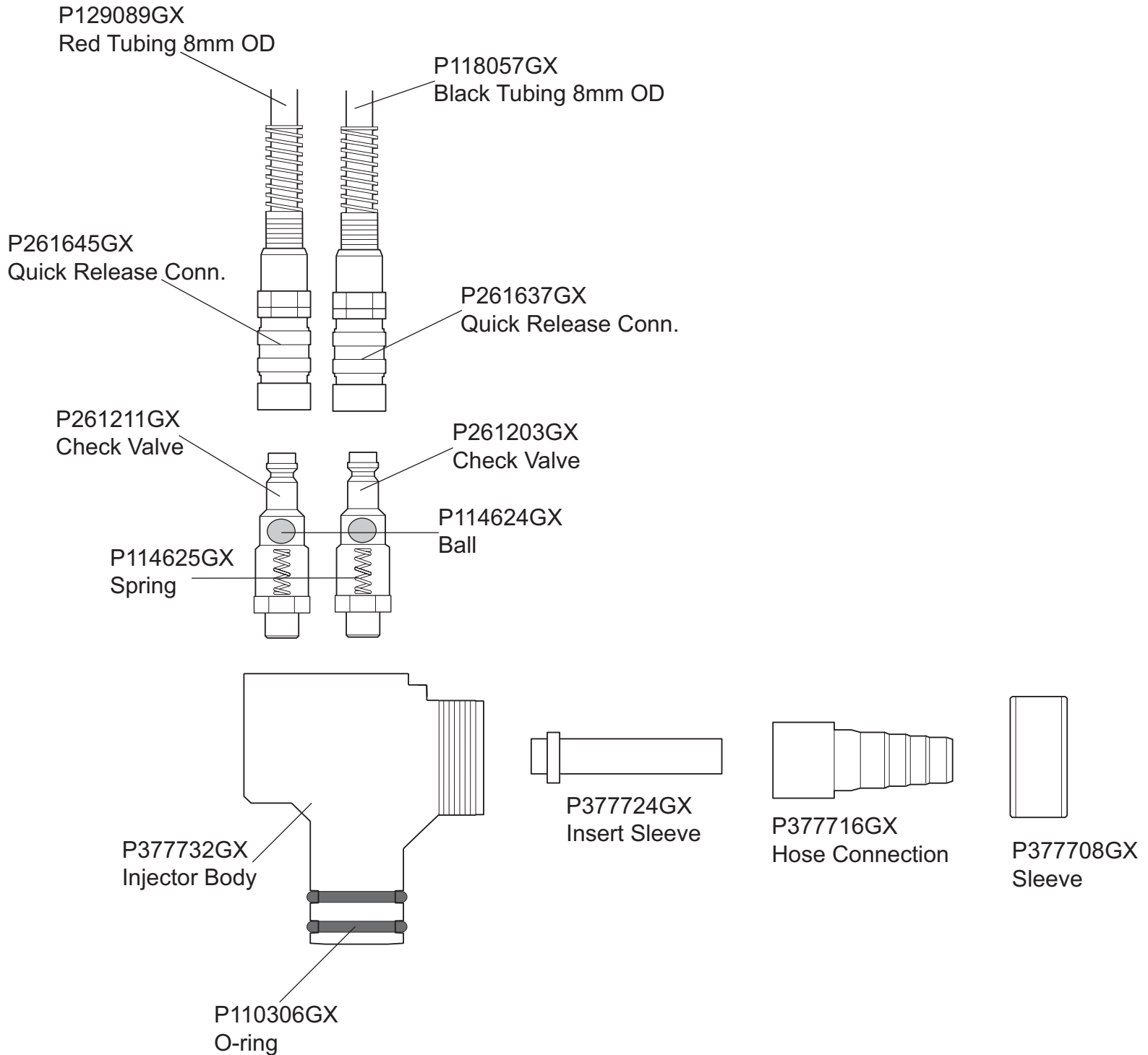

All parts are manufactured by or for Powder Parts, Inc., as "after market" replacement parts for powder coating equipment. The trademark names are owned by their respective companies and are used only for customer convenience.

POWDER PARTS, inc.

PG-1 Manual Gun

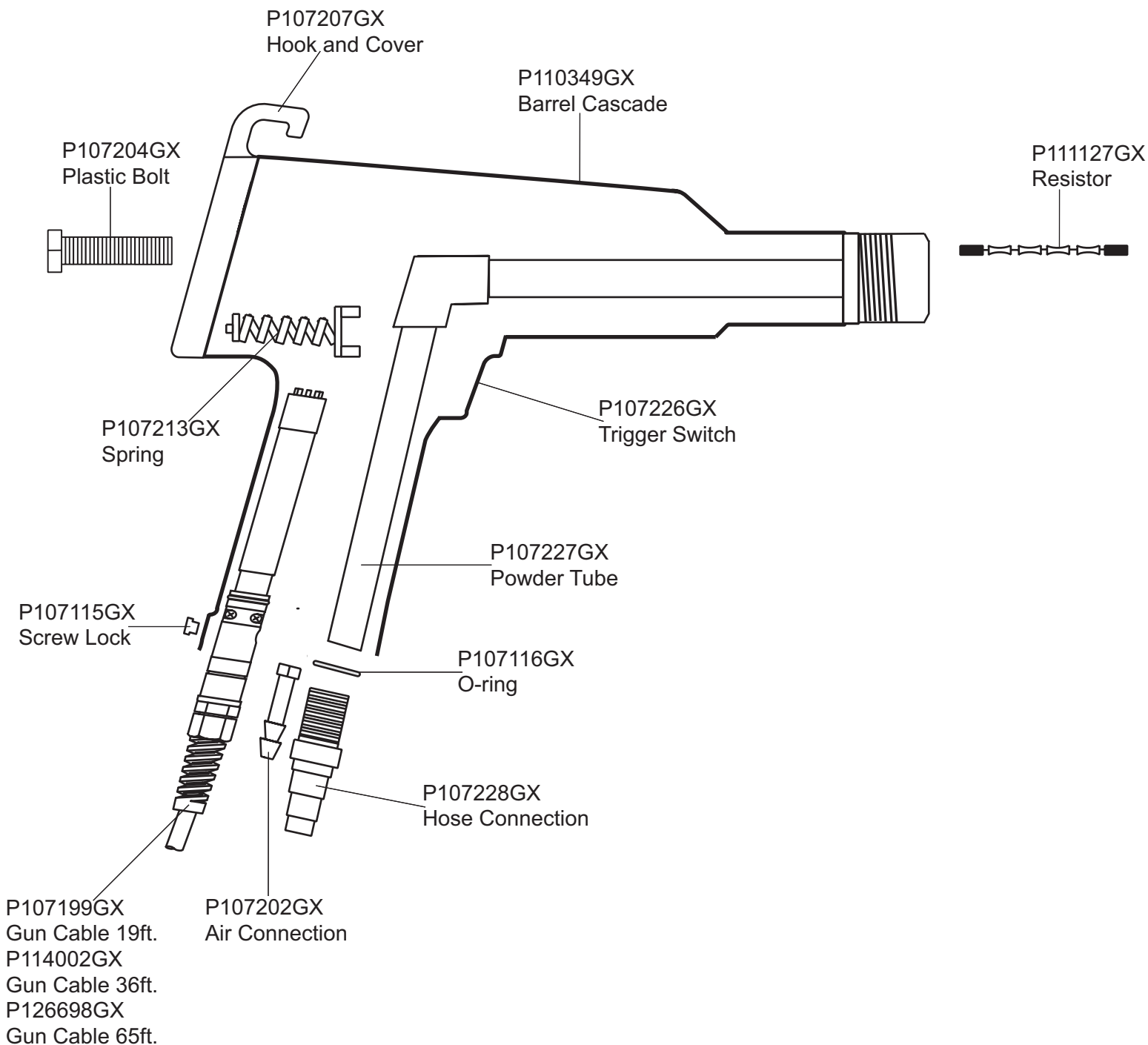

All parts are manufactured by or for Powder Parts, Inc., as "after market" replacement parts for powder coating equipment. The trademark names are owned by their respective companies and are used only for customer convenience.

POWDER PARTS, inc.

Nozzle Combination for PG Series Guns Old Style

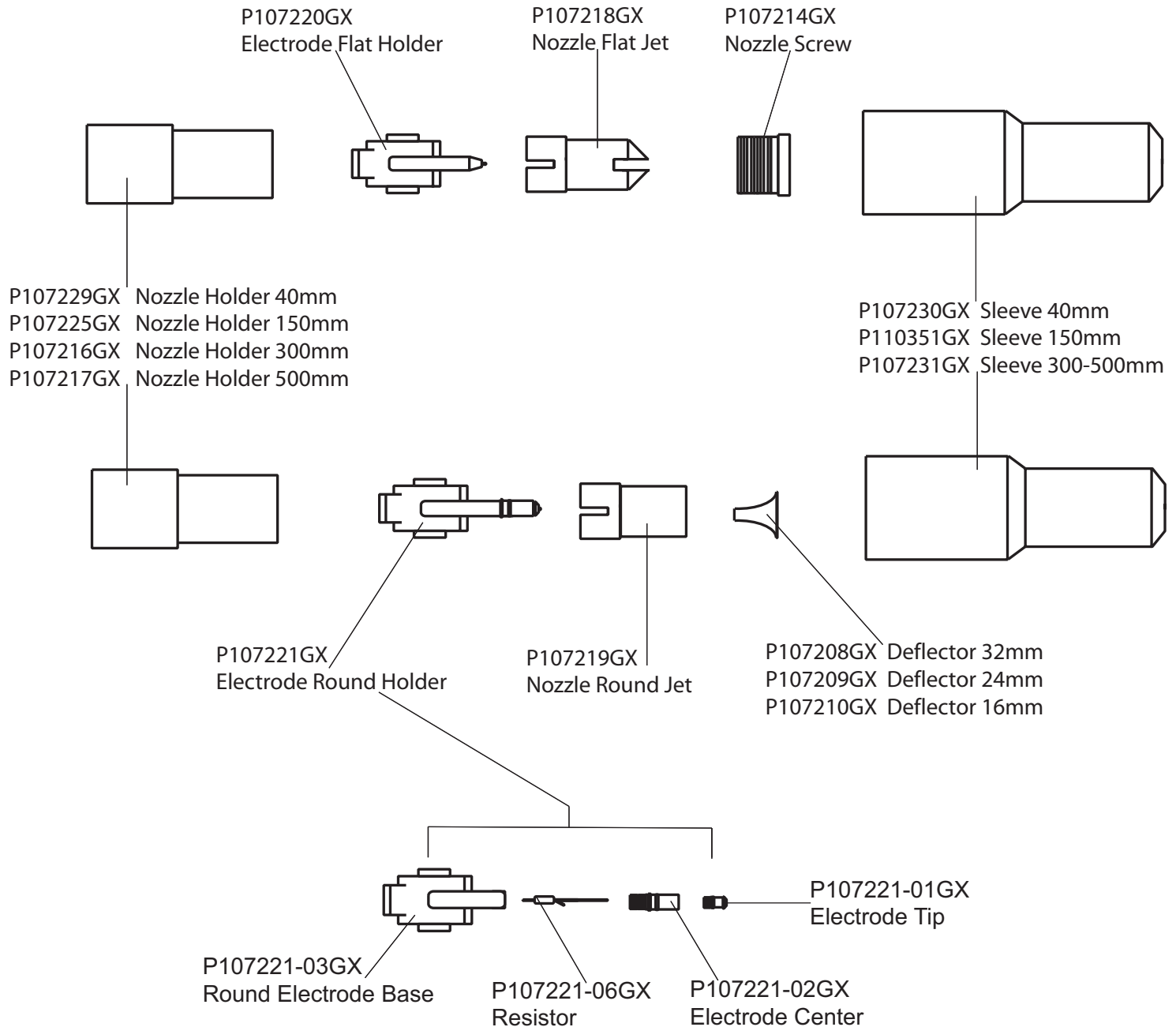

All parts are manufactured by or for Powder Parts, Inc., as "after market" replacement parts for powder coating equipment. The trademark names are owned by their respective companies and are used only for customer convenience.

POWDER PARTS, inc.

Nozzle Combination for PG Series Guns New Style



P107188GX
Contact Ring



P116063GX'
Electrode Flat Holder

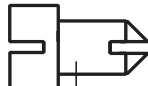

P107187GX
Nozzle Flat Jet



P116121GX
Sleeve



P107188GX
Contact Ring



P116064GX
Electrode Round Holder



P116126GX
Nozzle Round Jet



P107208GX Deflector 32mm
P117184GX Deflector 70mm
P117183GX Deflector 50mm
P107210GX Deflector 16mm
P107209GX Deflector 24mm



P116121GX
Sleeve



P116064-03GX
Round Electrode Base



P116064-06GX
Resistor



P116064-02GX
Electrode Center

P116064-01GX
Electrode Tip

PI-3 Powder Pump

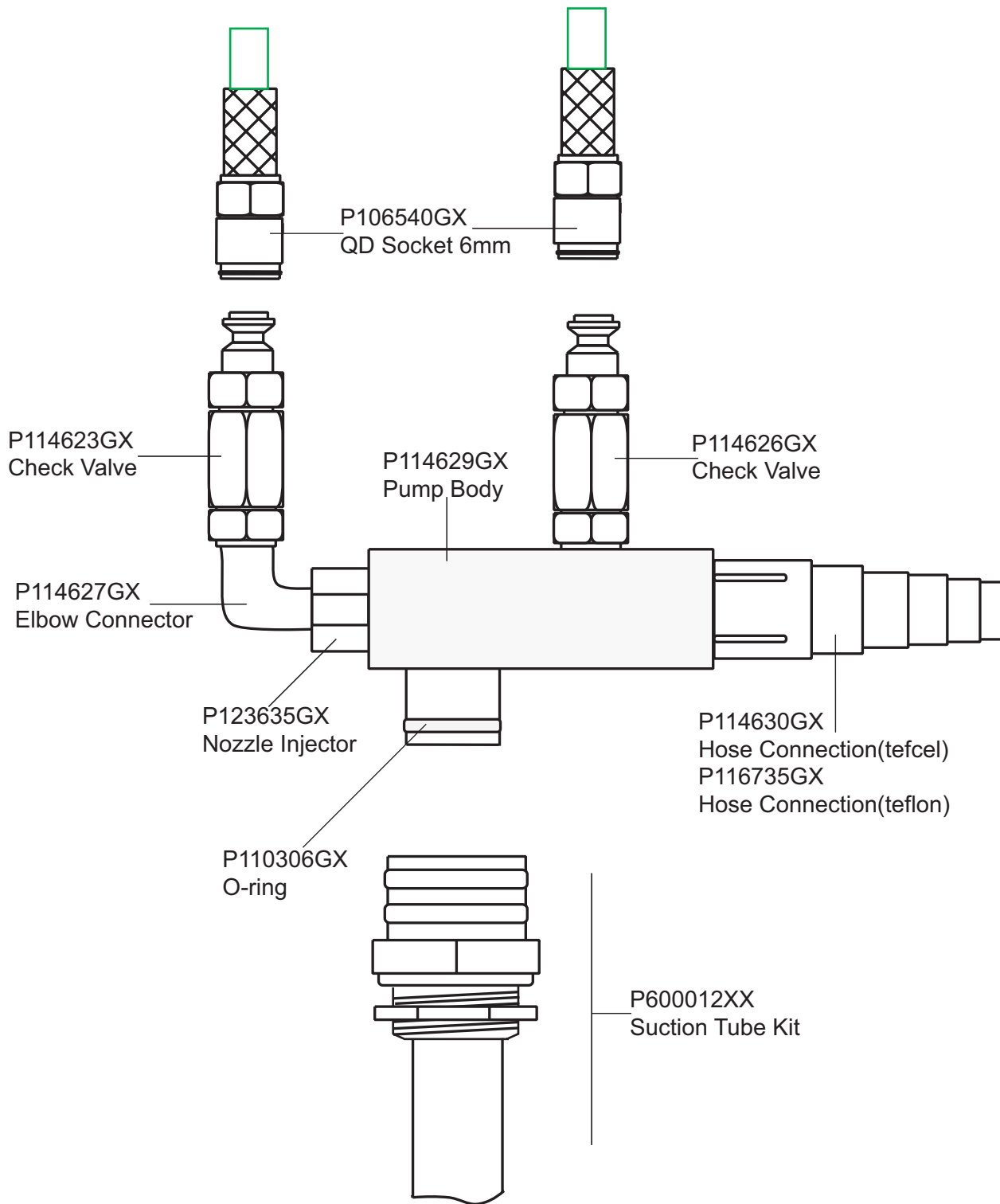

POWDER PARTS, inc.

HP75 Manual Gun

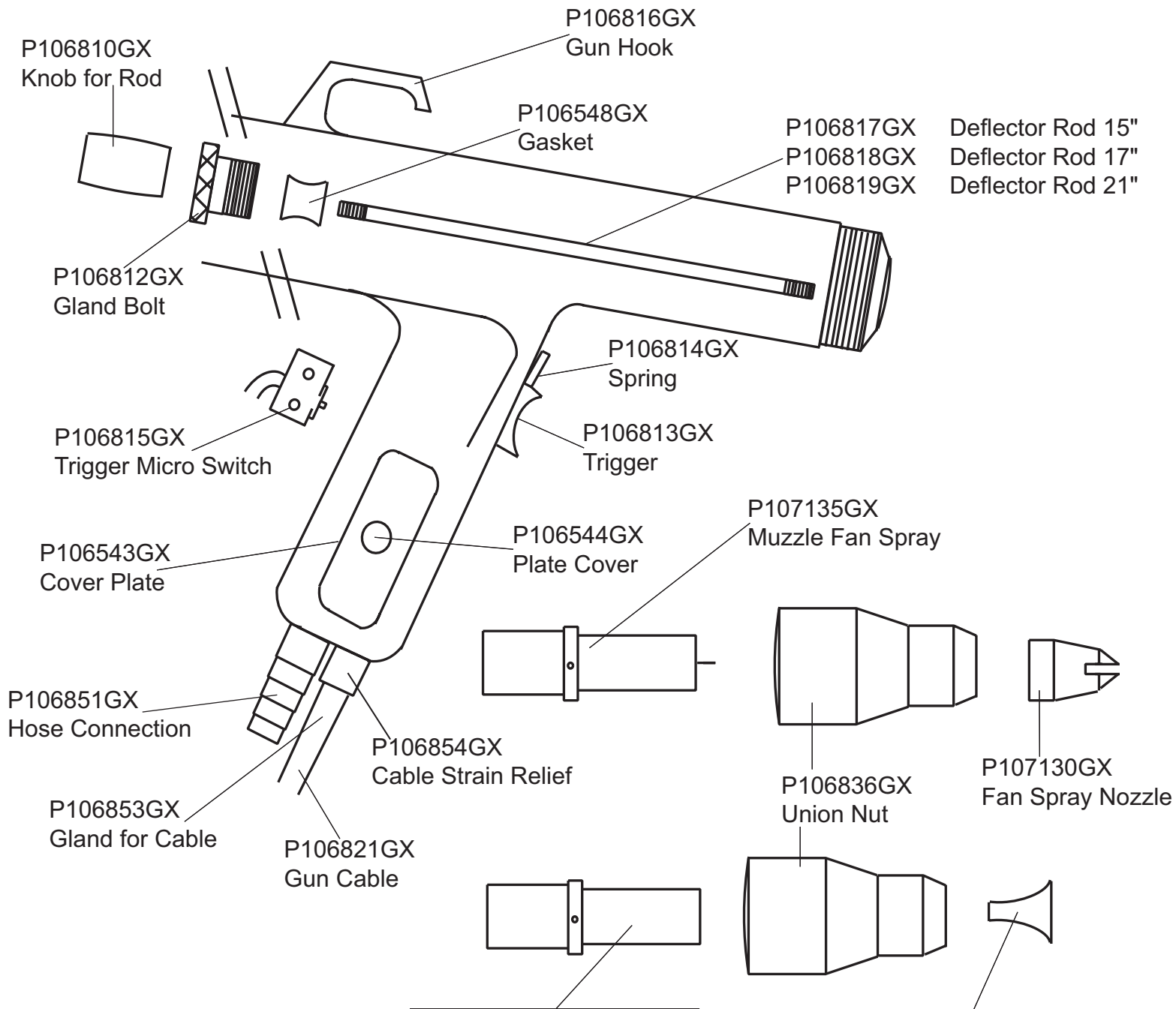

- P106829GX Muzzle 3.5"
- P106830GX Muzzle 7.5"
- P106831GX Muzzle 12"
- P106710GX Muzzle 1.25"

- P106839GX Deflector 12mm
- P106840GX Deflector 16mm
- P106841GX Deflector 20mm
- P106842GX Deflector 24mm
- P106843GX Deflector 28mm
- P106844GX Deflector 32mm
- P106845GX Deflector 2"

All parts are manufactured by or for Powder Parts, Inc., as "after market" replacement parts for powder coating equipment. The trademark names are owned by their respective companies and are used only for customer convenience.

PI-1 Powder Pump

